

No.	NAME	MODEL	DIMENSION	QUANTITY
	Electric Automatic Gyoza Cooker	MAZE-C44S3	600x700x330	

Type	2 Pan (4 servings)
Pan dimension	220 (W) x 330 (D) x t9.0 x 2
Power	1φ 230V 50/60Hz 3.0kVA x2
Power consumption	3.0kW x2
Rated current	13.1A x2
Weight	66kg
Accessory	Trash receiver X1

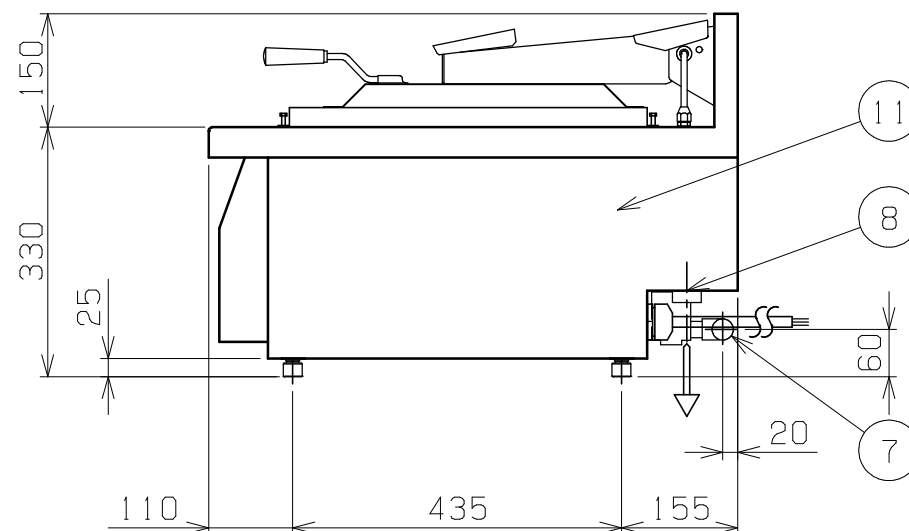
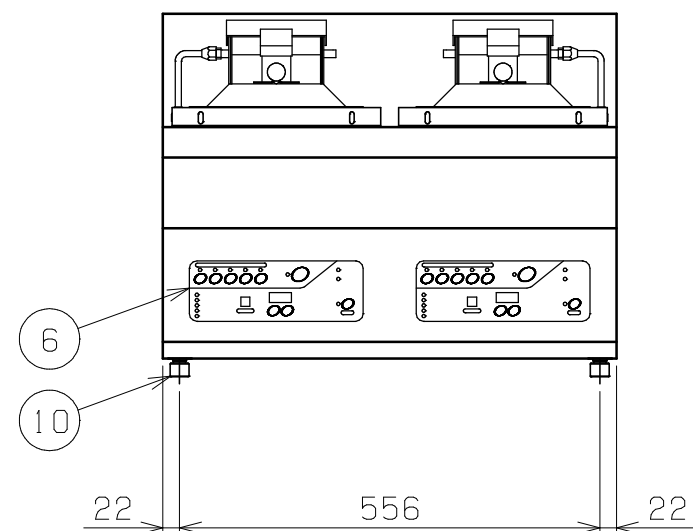
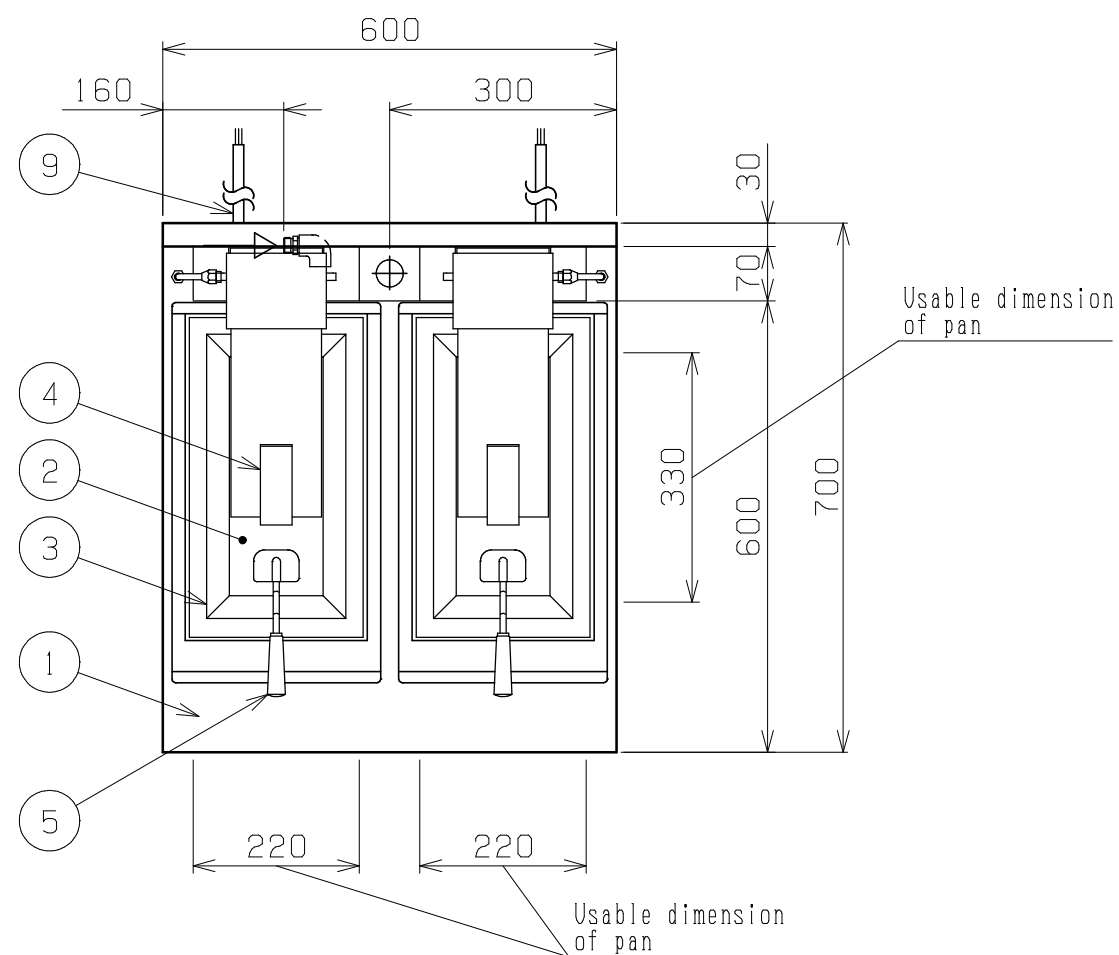
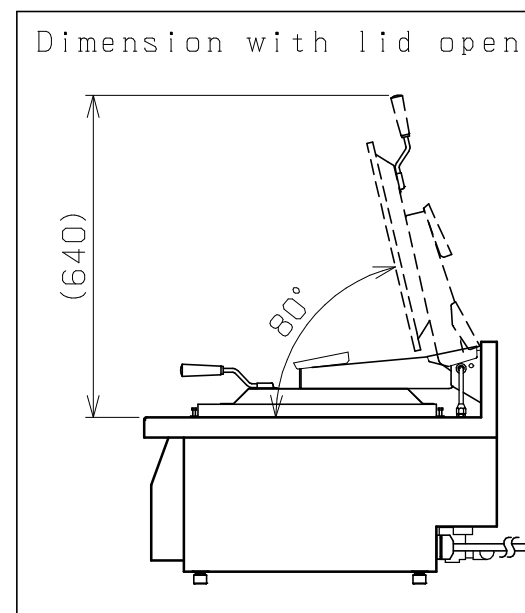

No.	Parts name	Material	Note
1	Top	SUS430	#400
2	Pan	clad steel plate	Pan frame (SUS430)
3	Lid	SUS430	Removable
4	Damper		
5	Handle	Nylon	
6	Operation panel		
7	Feed-water inlet		15A (G1/2)
8	Drain outlet		25A (Rp1)
9	Power cord		2m 14AWG-3core
10	Adjust	SUS304	
11	Side plate	SUS430	#400

※ Perform installation and construction according to local laws.
 ※ For improvement, specifications and the appearance may change without any notice.



General commercial kitchen Appliances & Equipment



ALTERATION	SCALE A3: 1/10	DATE	DRAWING No. 09462	TITLE	DATE OF DELIVERY
CHECK	DESIGN	DRAW	CHARGE	DRAWING CORD Electric Automatic Gyoza Cooker	No.