

No.	NAME	MODEL	DIMENSION	QUANTITY
	Electric Automatic Gyoza Cooker	MAZE-C4S2	300×700×330	

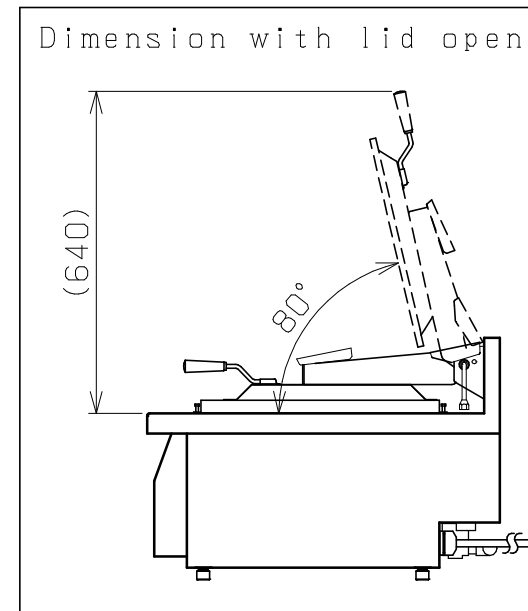

Type	1 Pan (4 servings)
Pan dimension	220 (W) × 330 (D) × t9.0
Power	1φ 220V 50/60Hz 3.0kVA
Power consumption	3.0kW
Rated current	13.7A
Weight	40kg
Accessory	Trash receiver X1

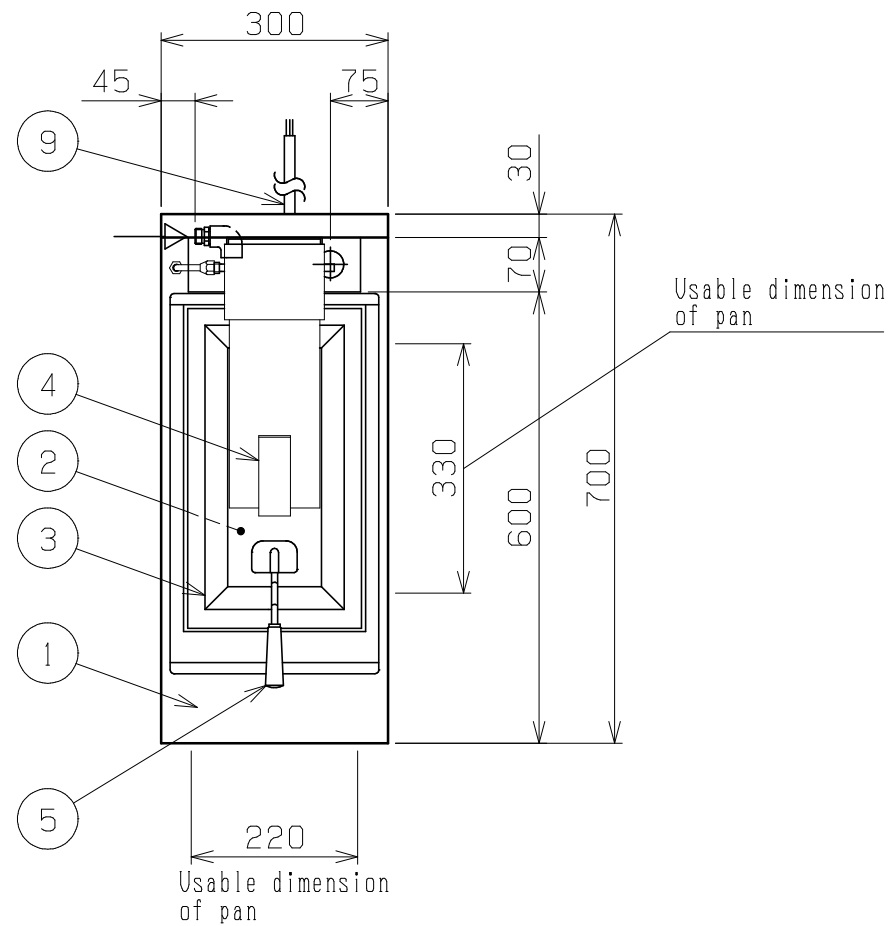
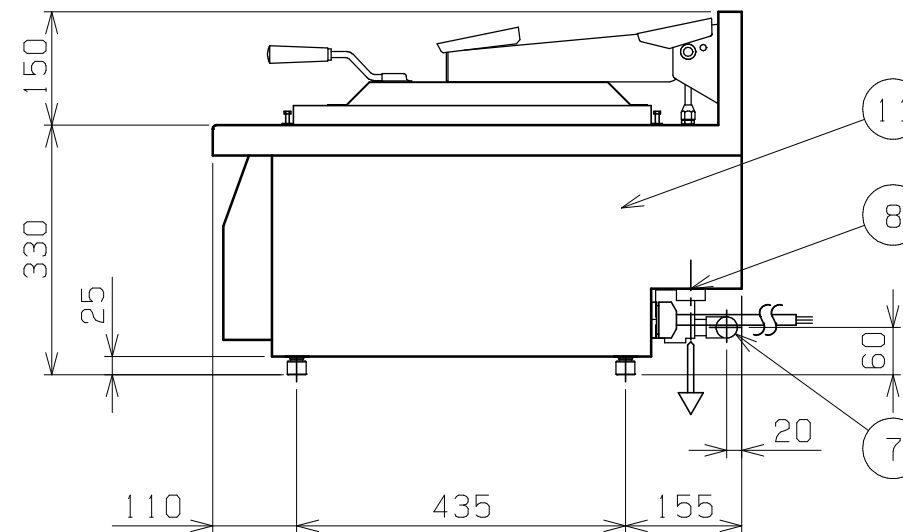
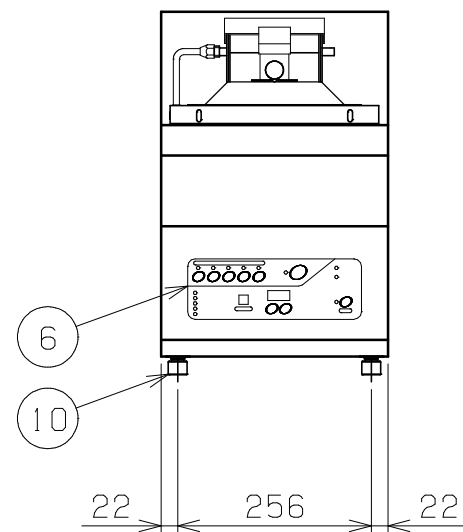

No.	Parts name	Material	Note
1	Top	SUS430	#400
2	Pan	clad steel plate	Pan frame (SUS430)
3	Lid	SUS430	Removable
4	Damper		
5	Handle	Nylon	
6	Operation panel		
7	Feed-water inlet		15A (G1/2)
8	Drain outlet		25A (Rp1)
9	Power cord		2m 14AWG-3core
10	Adjust	SUS304	
11	Side plate	SUS430	#400

※ Perform installation and construction according to local laws.
 ※ For improvement, specifications and the appearance may change without any notice.



General commercial kitchen Appliances & Equipment



ALTERATION

SCALE
A3: 1/10

DATE

DRAWING No.
09455

TITLE

DATE OF DELIVERY

CHECK

DESIGN

DRAW

CHARGE

DRAWING CORD

Electric Automatic Gyoza Cooker

No.